	Datasheet	No.	DS10-J002
		Initial Date	2014-05-28
OJ	OJ7M8A103	Written Team	R&D Dept.
			GH Zheng

I Preview

PN	OJ7M8A103
Description	40G QSFP+ eSR4 850nm 0.3KM MPO DDMI 0~70 °C

II Contents

1. Features
2. Applications
3. Description
4. Absolute maximum Ratings
5. Operating Environment
6. Optical and Electrical Characteristics
7. Digital Diagnostic Memory Map
8. Pin Descriptions
9. Mechanical Dimensions
10. Model Ordering Information

III Revision History

No.	Date	Items	Change Recording	Ver.	Rev.	Customer
1	2014-05-28	All	Initial registration	000	000	Standard
2						
3						
4						
5						
6						

 Communication Limited	Datasheet		DS10-J002 Final Rev.: 2014-05-28	
	Product	40G QSFP+ transceiver OJ serials	Ver.	000
	Part No.	OJ7M8A103	Rev.	000
			Page	2 / 8

1. Features:

- ◆ 4 channels full-duplex transceiver modules
- ◆ Transmission data rate up to 10.5Gbps per channel
- ◆ 4 channels 850nm VCSEL array
- ◆ 4 channels PIN photo detector array
- ◆ Single MPO connector receptacle
- ◆ Hot Pluggable QSFP+ form factor
- ◆ Maximum link length of 300m on OM3 Multimode Fiber (MMF) and 400m on OM4 MMF
- ◆ Compatible with RoHS
- ◆ Single +3.3V power supply
- ◆ Real Time Digital Diagnostic Monitoring
- ◆ Operating case temperature: 0 to +70°C

2. Applications

- ◆ 40GBASE-SR4 Ethernet
- ◆ Switch, router and HBAs
- ◆ Infiniband transmission at 4 channels SDR, DDR and QDR
- ◆ High-performance Backplane Applications
- ◆ Proprietary Protocol Applications

3. Description

The 40G QSFP+ eSR4 transceivers are high performance, cost effective modules supporting data rate of 40Gbps and 300m transmission distance with MMF. The transceiver consists of three sections: 4 channels 850nm VCSEL array, 4 channels PIN photo detector array and MCU control unit. All modules satisfy class I laser safety requirements. The transceivers are compatible with 40GBASE-SR4 of IEEE802.3ba standard and SFF-8436 specification.

OCRE COMMUNICATION LIMITED Web: www.ocrecom.com E-Mail: sales@ocrecom.com Add. Dist.A, Building 6, Bay on the six block, Xixiang, Baoan Dist, Shenzhen, China 518000 Tel: + 86 755 2335 3855 Fax: + 86 755 2335 3855	DESIGN	CHECK	CHECK	APPROVAL

 CRE Communication Limited	Datasheet		DS10-J002 Final Rev.: 2014-05-28	
	Product	40G QSFP+ transceiver OJ serials	Ver.	000
	Part No.	OJ7M8A103	Rev.	000
			Page	3 / 8

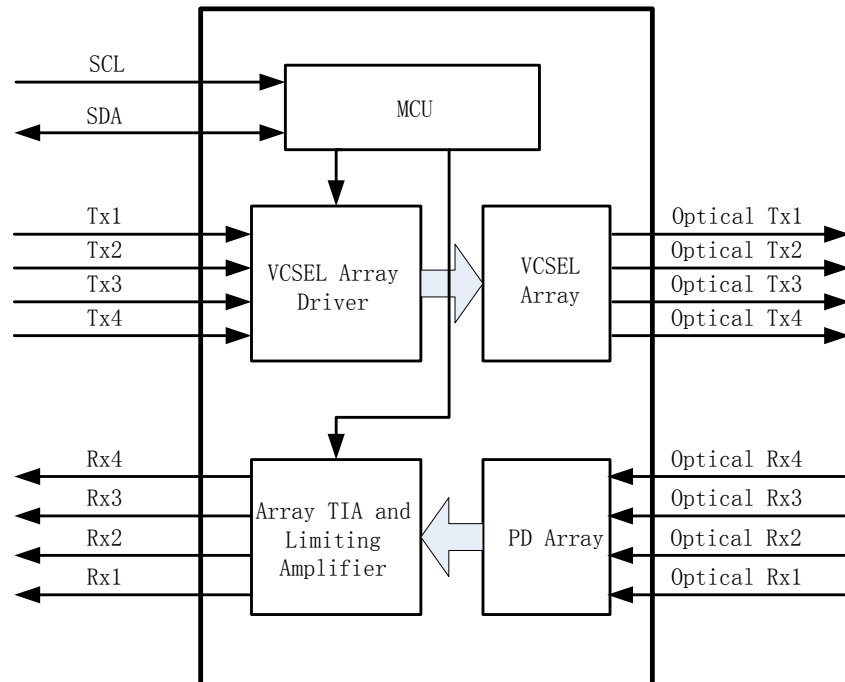

Transceiver functional diagram

4. Absolute Maximum Ratings

Parameter	Symbol	Min	Max	Unit
Supply Voltage	Vcc	-0.5	4.5	V
Storage Temperature	Ts	-20	+85	°C
Operating Humidity	-	5	85	%

5. Operating Environment

Parameter	Symbol	Min	Typical	Max	Unit
Operating Case Temperature	Tc	0		+70	°C
Power Supply Voltage	Vcc	3.135	3.30	3.465	V
Power Dissipation	Pm			1.5	W
Data Rate			10.3	10.5	Gbps

6. Optical and Electrical Characteristics

Parameter	Symbol	Min	Typical	Max	Unit	Notes
Transmitter						

OCRE COMMUNICATION LIMITED Web: www.ocrecom.com E-Mail: sales@ocrecom.com Add. Dist.A, Building 6, Bay on the six block, Xixiang, Baoan Dist, Shenzhen, China 518000 Tel: + 86 755 2335 3855 Fax: + 86 755 2335 3855	DESIGN	CHECK	CHECK	APPROVAL

 Communication Limited	Datasheet		DS10-J002 Final Rev.: 2014-05-28	
	Product	40G QSFP+ transceiver OJ serials	Ver.	000
	Part No.	OJ7M8A103	Rev.	000
			Page	4 / 8

Centre Wavelength	λ_c	840	850	860	nm	
RMS spectral width	$\Delta\lambda$	-	-	0.65	nm	
Average launch power, each lane	P_{out}	-7.6		2.4	dBm	
Extinction Ratio	ER	3.0			dB	
Average launch power of OFF transmitter,each lane	P_{off}			-30	dBm	
Data Input Swing Differential	V_{IN}	90		1600	mV	
Input Differential Impedance	Z_{IN}	80	100	120	Ω	
Receiver						
Centre Wavelength	λ_c	840		860	nm	
Damage threshold	THd	3.4			dBm	
Average power at receiver input,each lane		-9.9		2.4	dBm	
LOS De-Assert	LOS _D			-12	dBm	
LOS Assert	LOS _A	-30			dBm	
LOS Hysteresis		0.5			dB	

7. Digital Diagnostic Memory Map

The transceivers provide serial ID memory contents and diagnostic information about the present operating conditions by the 2-wire serial interface (SCL, SDA).

The digital diagnostic memory map specific data field defines as following.

OCRE COMMUNICATION LIMITED Web: www.ocrecom.com E-Mail: sales@ocrecom.com Add. Dist.A, Building 6, Bay on the six block, Xixiang, Baoan Dist, Shenzhen, China 518000 Tel: + 86 755 2335 3855 Fax: + 86 755 2335 3855	DESIGN	CHECK	CHECK	APPROVAL

 CRE Communication Limited	Datasheet		DS10-J002 Final Rev.: 2014-05-28	
	Product	40G QSFP+ transceiver OJ serials	Ver.	000
	Part No.	OJ7M8A103	Rev.	000
			Page	5 / 8

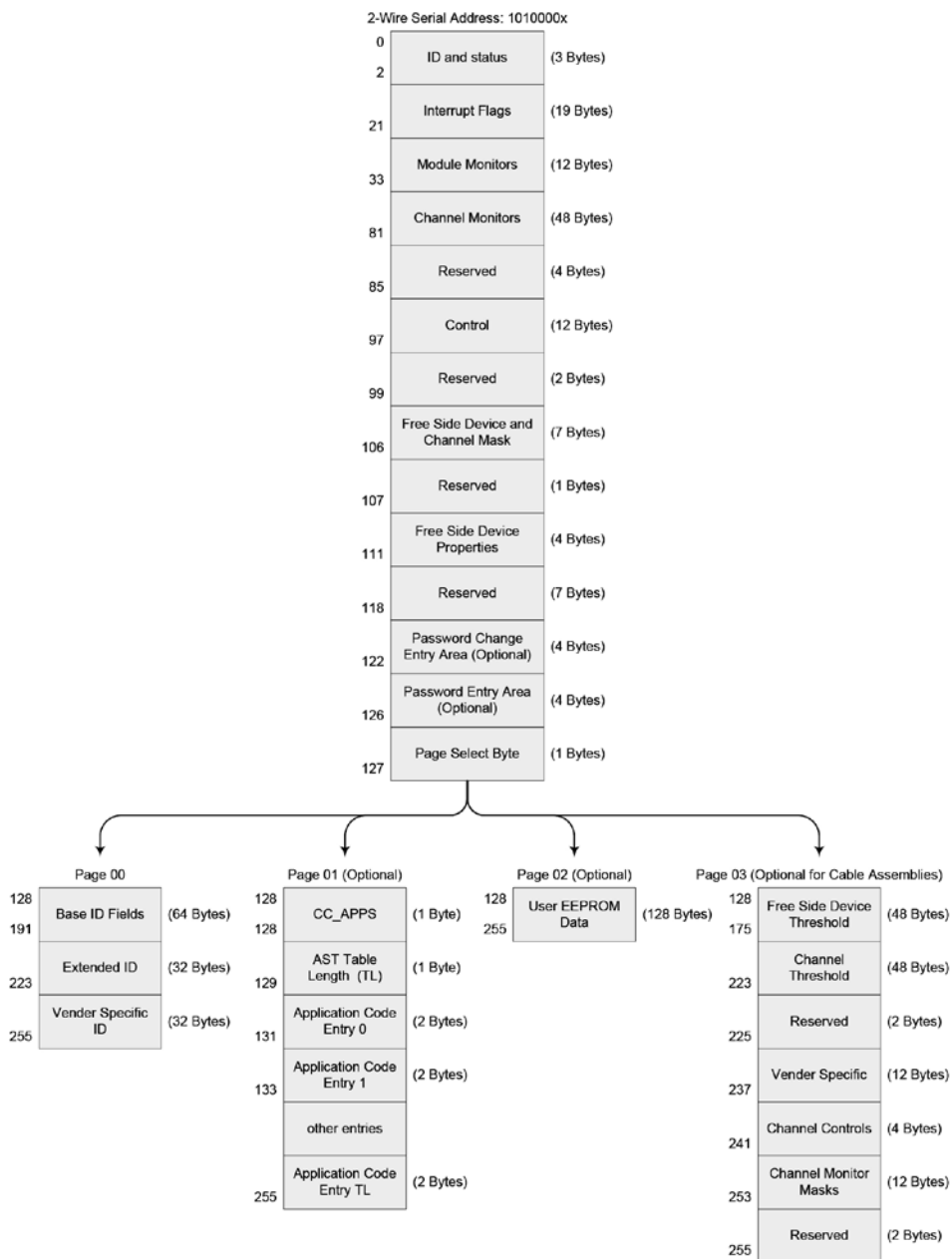

8. Pin Descriptions

OCRE COMMUNICATION LIMITED Web: www.ocrecom.com E-Mail: sales@ocrecom.com Add. Dist.A, Building 6, Bay on the six block, Xixiang, Baoan Dist, Shenzhen, China 518000 Tel: + 86 755 2335 3855 Fax: + 86 755 2335 3855	DESIGN	CHECK	CHECK	APPROVAL



Communication Limited

Datasheet

DS10-J002
Final Rev.: 2014-05-28

Product	40G QSFP+ transceiver OJ serials	Ver.	000
Part No.	OJ7M8A103	Rev.	000
		Page	6 / 8

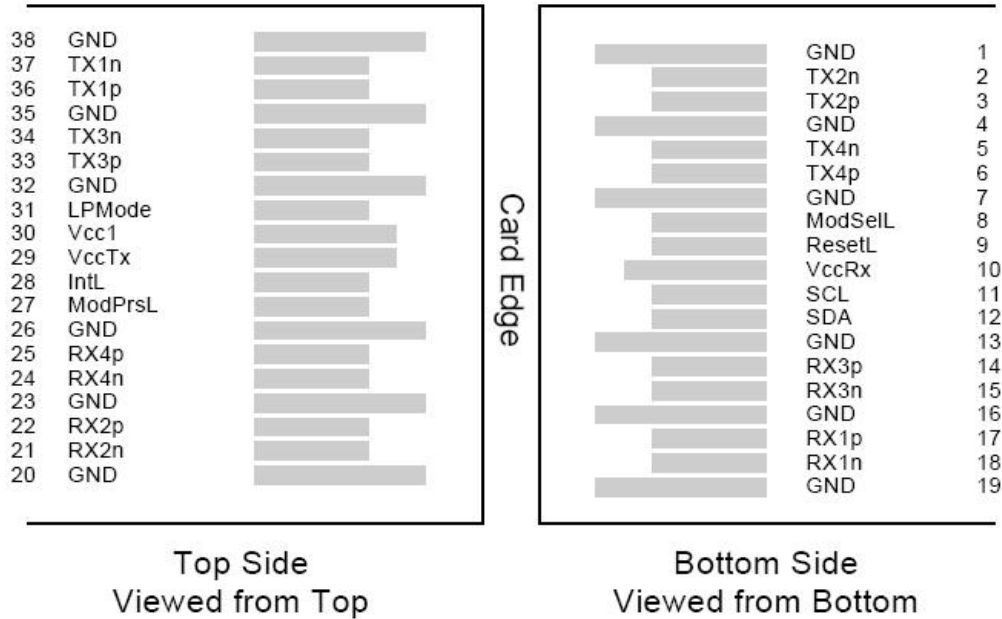

PIN	Logic	Symbol	Name/Description	Note
1		GND	Ground	1
2	CML-I	Tx2n	Transmitter Inverted Data Input	
3	CML-I	Tx2p	Transmitter Non-Inverted Data output	
4		GND	Ground	1
5	CML-I	Tx4n	Transmitter Inverted Data Input	
6	CML-I	Tx4p	Transmitter Non-Inverted Data output	
7		GND	Ground	1
8	LVILL-I	ModSelL	Module Select	
9	LVILL-I	ResetL	Module Reset	
10		VccRx	+ 3.3V Power Supply Receiver	2
11	LVC MOS-I/O	SCL	2-Wire Serial Interface Clock	
12	LVC MOS-I/O	SDA	2-Wire Serial Interface Data	
13		GND	Ground	
14	CML-O	Rx3p	Receiver Non-Inverted Data Output	
15	CML-O	Rx3n	Receiver Inverted Data Output	
16		GND	Ground	1
17	CML-O	Rx1p	Receiver Non-Inverted Data Output	

OCRE COMMUNICATION LIMITED Web: www.ocrecom.com E-Mail: sales@ocrecom.com Add. Dist.A, Building 6, Bay on the six block, Xixiang, Baoan Dist, Shenzhen, China 518000 Tel: + 86 755 2335 3855 Fax: + 86 755 2335 3855	DESIGN	CHECK	CHECK	APPROVAL

 CRE Communication Limited	Datasheet		DS10-J002 Final Rev.: 2014-05-28	
	Product	40G QSFP+ transceiver OJ serials	Ver.	000
	Part No.	OJ7M8A103	Rev.	000
			Page	7 / 8

18	CML-O	Rx1n	Receiver Inverted Data Output	
19		GND	Ground	1
20		GND	Ground	1
21	CML-O	Rx2n	Receiver Inverted Data Output	
22	CML-O	Rx2p	Receiver Non-Inverted Data Output	
23		GND	Ground	1
24	CML-O	Rx4n	Receiver Inverted Data Output	1
25	CML-O	Rx4p	Receiver Non-Inverted Data Output	
26		GND	Ground	1
27	LVTTL-O	ModPrsL	Module Present	
28	LVTTL-O	IntL	Interrupt	
29		VccTx	+3.3 V Power Supply transmitter	2
30		Vcc1	+3.3 V Power Supply	2
31	LVTTL-I	LPMode	Low Power Mode	
32		GND	Ground	1
33	CML-I	Tx3p	Transmitter Non-Inverted Data Input	
34	CML-I	Tx3n	Transmitter Inverted Data Output	
35		GND	Ground	1
36	CML-I	Tx1p	Transmitter Non-Inverted Data Input	
37	CML-I	Tx1n	Transmitter Inverted Data Output	
38		GND	Ground	1

Notes:

1. GND is the symbol for signal and supply (power) common for QSFP modules. All are common within the QSFP module and all module voltages are referenced to this potential unless otherwise noted. Connect these directly to the host board signal common ground plane.

2. VccRx, Vcc1 and VccTx are the receiver and transmitter power suppliers and shall be applied concurrently. Recommended host board power supply filtering is shown below. Vcc Rx, Vcc1 and Vcc Tx may be internally connected within the QSFP transceiver module in any combination. The connector pins are each rated for a maximum current of 500mA.

9. Mechanical Dimensions

OCRE COMMUNICATION LIMITED Web: www.ocrecom.com E-Mail: sales@ocrecom.com Add. Dist.A, Building 6, Bay on the six block, Xixiang, Baoan Dist, Shenzhen, China 518000 Tel: + 86 755 2335 3855 Fax: + 86 755 2335 3855	DESIGN	CHECK	CHECK	APPROVAL

 CRE Communication Limited	Datasheet		DS10-J002 Final Rev.: 2014-05-28	
	Product	40G QSFP+ transceiver OJ serials	Ver.	000
	Part No.	OJ7M8A103	Rev.	000
			Page	8 / 8

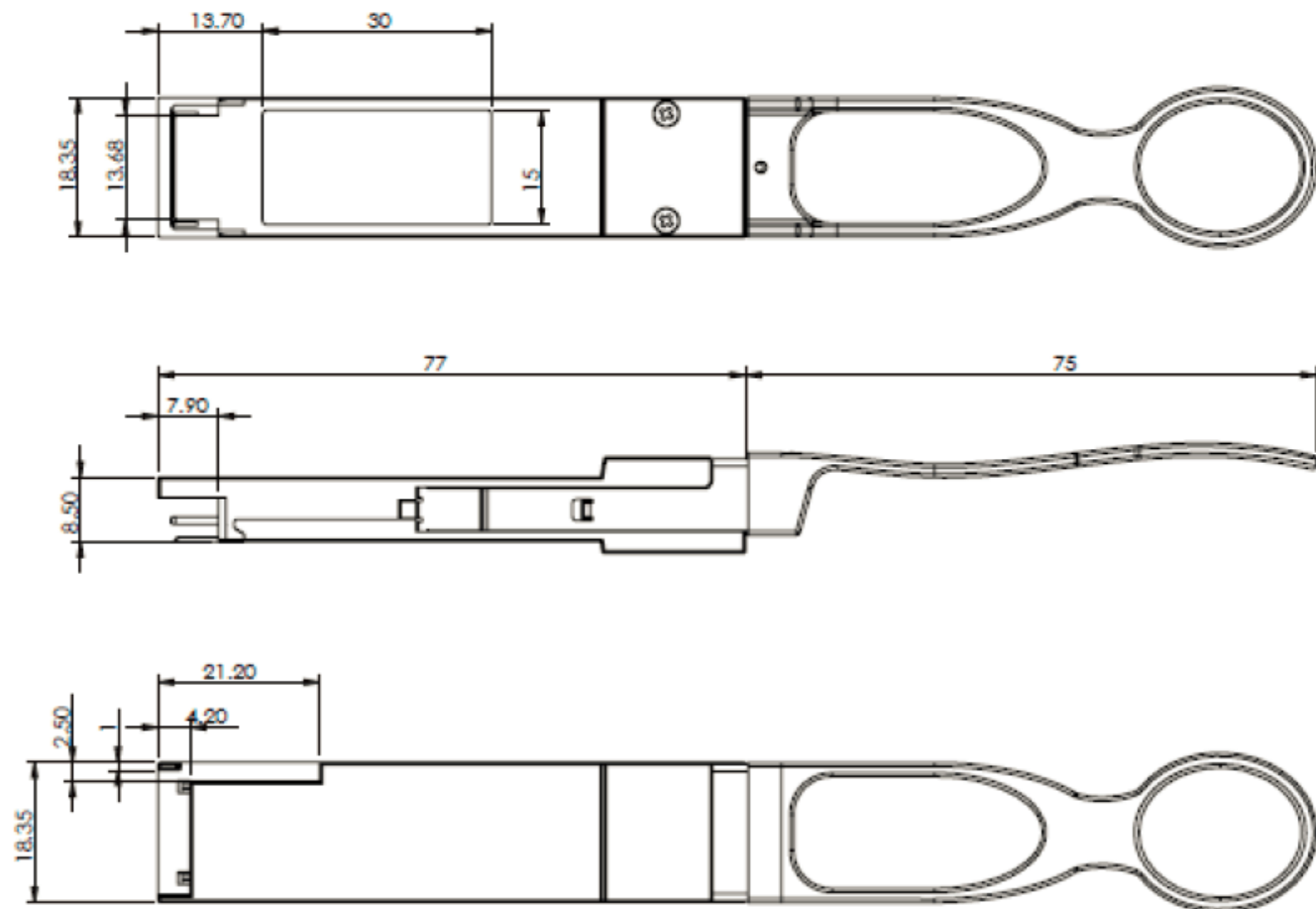

10. Module Ordering information

PN	Description
OJ7M8A103	40G QSFP+ eSR4 850nm 0.3KM MPO DDMI 0~70 °C

OCRE COMMUNICATION LIMITED Web: www.ocrecom.com E-Mail: sales@ocrecom.com Add. Dist.A, Building 6, Bay on the six block, Xixiang, Baoan Dist, Shenzhen, China 518000 Tel: + 86 755 2335 3855 Fax: + 86 755 2335 3855	DESIGN	CHECK	CHECK	APPROVAL