



Datasheet

No.

DS10-E013

Initial Date

2017-01-18

OE

OEIS341

Written Team

R&D Dept.

GH Zheng

I Preview

PN	OEIS341
Description	SFP+ 12G SDI 1310nm 20KM

II Contents

1. Features
2. Applications
3. Description
4. Absolute maximum Ratings
5. Operating Environment
6. Optical Characteristics
7. Electrical Characteristics
8. Pin Information
9. Digital Diagnostic Monitor Characteristics
10. Mechanical Dimensions
11. Recommended Circuit
12. Model Name Information

III Revision History

No.	Date	Items	Change Recording	Ver.	Rev.	Customer
1	2017-01-18	All	Initial registration	000	000	Standard
2						
3						
4						
5						
6						

 CRE Communication Limited	Datasheet		DS10-E013 Final Rev.:2017.01.18	
	Product	SFP+ transceiver OE serials	Ver.	000
	Part No.	OEIS341	Rev.	000
			Page	2 / 7

1. Features:

- ◆ 12G SDI SFP+ transceiver
- ◆ 1310nm DFB Laser and PIN receiver
- ◆ Support Video pathological patterns for SD-SDI, HD-SDI, 12G SDI
- ◆ SFP MSA package with duplex LC connector
- ◆ 2-wire interface for management and diagnostic monitor
- ◆ +3.3V single power supply
- ◆ Operating case temperature: 0~+70°C
- ◆ Compliant with SFF-8472 Rev 10.2
- ◆ RoHS Compliant

2. Applications:

- ◆ SMPTE ST-297-2015, ST2081 and ST-2082 Compatible Electrical-to-Optical Interfaces.
- ◆ UHD TV/HDTV/SDTV Service Interfaces.

3. Description:

OEIS341 is a video series transceivers are high performance, cost effective modules for duplex video transmission application over single mode fiber. The transceiver is designed to transmit/receive data rates from 50Mbps to 11.88Gbps and is specifically designed for robust performance in the presence of SDI pathological patterns. The transceiver consists of three sections: a DFB laser, a PIN photodiode integrated with a trans-impedance preamplifier (TIA) and transceiver IC with MCU control unit for DDM. All modules satisfy class I laser safety requirements. The transceivers are compatible with SFP Multi-Source Agreement (MSA) and SFF-8472. For further information, please refer to SFP MSA.

4. Absolute Maximum Ratings

Parameter	Symbol	Remarks	Min.	Max.
Storage Temperature	T _{ST}	-40	+85	°C
Supply Voltage	V _{CC3}	-0.5	+4.5	V
Relative Humidity	RH	5	85	%

5. Operation Environment:

Parameter	Symbol	Min	Typ	Max	Unit
Date Rate			12		Gb/s
Supply Voltage	V _{CC}	+3.14	3.3	+3.47	V
Supply Current	I _{CC}			250	mA
Power Dissipation	PD		200	300	mW
Operating Temperature	T _{OP}	0	25	+70	°C

6. Optical Characteristics (Condition: T_a=T_{OP})

OCRE COMMUNICATION LIMITED Web: www.ocrecom.com E-Mail: sales@ocrecom.com Add. Dist.A, Building 6, Bay on the six block, Xixiang, Baoan Dist, Shenzhen, China 518000 Tel: + 86 755 2335 3855 Fax: + 86 755 2335 3855	DESIGN	CHECK	CHECK	APPROVAL

 CRE Communication Limited	Datasheet		DS10-E013 Final Rev.:2017.01.18	
	Product	SFP+ transceiver OE serials	Ver.	000
	Part No.	OEIS341	Rev.	000
			Page	3 / 7

Parameter	Symbol	Min	Typ	Max	Unit	Ref.
Transmitter						
Date Rate			12		Gb/s	
Optical Wavelength	λ	1300	1310	1320	nm	
Average output power	Po	-5		-2	dBm	1
Optical Extinction Ratio	ER	3.5			dB	
Side Mode Suppression Ratio	SMSR	30	-		dBm	
RMS spectral width	$\Delta\lambda$			1	nm	
Receiver						
Date Rate			12		Gb/s	
Optical Wavelength	λ	1260		1580	nm	
Receiver Sensitivity(OMA)	R			-14	dBm	5
Maximum Input Power	P _{MAX}	0.5			dBm	4
LOS De-Assert	LOSD			-20	dBm	
LOS Assert	LOSA	-28			dBm	
LOS Hysteresis		1		4	dB	

Notes:

- 1) Measured at 10.3125b/s with PRBS 2³¹ – 1 NRZ test pattern.
- 2) Under the ER worst case, measured at 10.3125 Gb/s with PRBS 2³¹ – 1 NRZ test pattern for BER < 1x10⁻¹²

7. Electrical Characteristics (Condition: T_a=T_{op})

Parameter	Symbol	Min	Typ	Max	Unit	Note
Transmitter:						
Differential input voltage swing	V _I	400		1800	mVpp	3
Transmit Disable Input	H	V _{IH}	2.0	V _{cc}	V	
	L	V _{IL}	0	0.8	V	
Transmit Enable Output	H	V _{OH}	2.0	V _{cc}	V	
	L	V _{OL}	0	0.8	V	
Timing Output Jitter	-			8	UI	6
Alignment Output Jitter	-			0.3	UI	6
Input Differential Impedance	Z _{in}	90	100	110	Ω	
Receiver:						
Differential output voltage swing		650	800	1000	mVpp	3
LOS Output	H	V _{OH}	2.0	V _{cc}	V	
	L	V _{OL}	0	0.8	V	
Rx Output Rise and Fall Time	Tr/Tf	45			ps	2
Output Differential Impedance	Z _{on}	80	100	120	Ω	

Notes:

- 1) . The optical power is launched into SMF.

OCRE COMMUNICATION LIMITED Web: www.ocrecom.com E-Mail: sales@ocrecom.com Add. Dist.A, Building 6, Bay on the six block, Xixiang, Baoan Dist, Shenzhen, China 518000 Tel: + 86 755 2335 3855 Fax: + 86 755 2335 3855	DESIGN	CHECK	CHECK	APPROVAL

 CRE Communication Limited	Datasheet		DS10-E013 Final Rev.:2017.01.18	
	Product	SFP+ transceiver OE serials	Ver.	000
	Part No.	OEIS341	Rev.	000
			Page	4 / 7

- 2) . Rise and fall times, 20% to 80%, are measured following a fourth-order Bessel-Thompson filter with a bandwidth of 0.75 x clock frequency corresponding to the serial data rate
- 3) . PECL input, internally AC-coupled and terminated.
- 4) . Internally AC-coupled, minimum input overload power for SMPTE ST 2081-1, SMPTE ST 2082-1.
- 5) . The sensitivity and overload specification refers to the input power levels for BER = 1E-12 against both PRBS and pathological patterns at SMPTE 259M, SMPTE 292M and SMPTE 424M rates, ST2081 and ST-2082.
- 6) . UI means one period.

8. Pin Information

Diagram of Host Board Connector Block Pin Numbers and Name

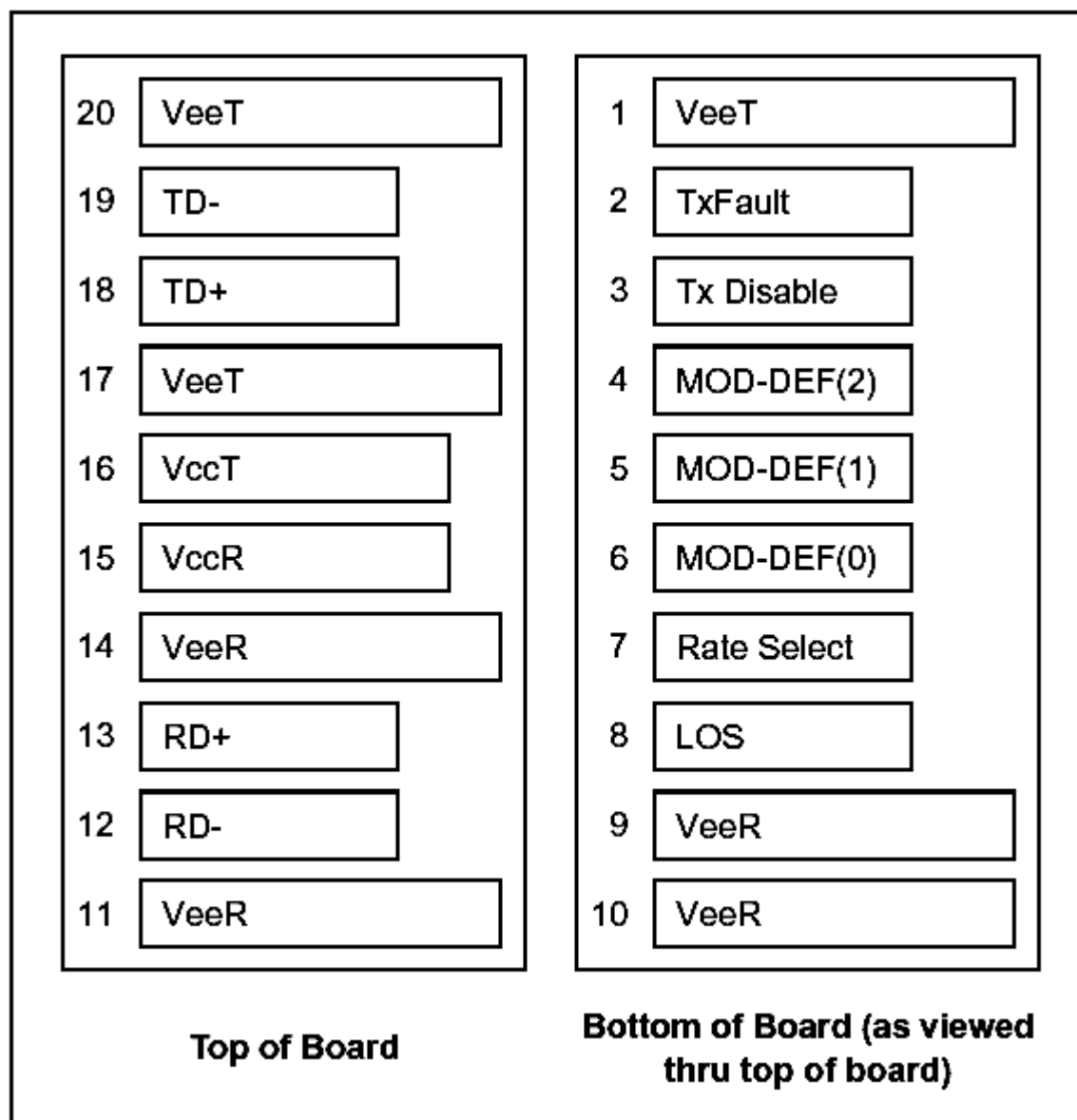

OCRE COMMUNICATION LIMITED Web: www.ocrecom.com E-Mail: sales@ocrecom.com Add. Dist.A, Building 6, Bay on the six block, Xixiang, Baoan Dist, Shenzhen, China 518000 Tel: + 86 755 2335 3855 Fax: + 86 755 2335 3855	DESIGN	CHECK	CHECK	APPROVAL

 CRE Communication Limited	Datasheet		DS10-E013 Final Rev.:2017.01.18	
	Product	SFP+ transceiver OE serials	Ver.	000
	Part No.	OEIS341	Rev.	000
			Page	5 / 7

PIN#	Name	Function	Notes
1	VeeT	Module transmitter ground	
2	Tx Fault	Module transmitter fault	Note 1
3	Tx Disable	Transmitter Disable; Turns off transmitter laser output	Note 2
4	MOD_DEF(2)	2 wire serial interface data input/output (SDA)	Note 3
5	MOD_DEF(1)	2 wire serial interface clock input (SCL)	Note 3
6	MOD_DEF(0)	TTL Low	Note 3
7	Rate Select	Receiver Rate Select , Not connect	
8	LOS	Receiver Loss of Signal Indication	
9	VeeR	Module receiver ground	
10	VeeR	Module receiver ground	
11	VeeR	Module receiver ground	
12	RD-	Receiver inverted data out put	Note 5
13	RD+	Receiver non-inverted data out put	Note 5
14	VeeR	Module receiver ground	
15	VccR	Module receiver 3.3V supply	
16	VccT	Module transmitter 3.3V supply	
17	VeeT	Module transmitter ground	
18	TD+	Transmitter inverted data out put	Note 6
19	TD-	Transmitter non-inverted data out put	Note 6
20	VeeT	Module transmitter ground	

Notes:

Plug Seq.: Pin engagement sequence during hot plugging.

1) TX Fault is an open collector output, which should be pulled up with a 4.7k~10kΩ resistor on the host board to a voltage between 2.0V and Vcc+0.3V. Logic 0 indicates normal operation; Logic 1 indicates a laser fault of some kind. In the low state, the output will be pulled to less than 0.8V.

2) TX Disable is an input that is used to shut down the transmitter optical output. It is pulled up within the module with a 4.7k~10kΩ resistor. Its states are:

Low (0 to 0.8V): Transmitter on

(>0.8V, <2.0V): Undefined

High (2.0 to 3.465V): Transmitter Disabled

Open: Transmitter Disabled

3) Mod-Def0,1,2. These are the module definition pins. They should be pulled up with a 4.7k~10kΩ resistor on the host board. The pull-up voltage shall be VccT or VccR.

Mod-Def 0 is grounded by the module to indicate that the module is present

Mod-Def 1 is the clock line of two wire serial interface for serial ID

Mod-Def 2 is the data line of two wire serial interface for serial ID

OCRE COMMUNICATION LIMITED Web: www.ocrecom.com E-Mail: sales@ocrecom.com Add. Dist.A, Building 6, Bay on the six block, Xixiang, Baoan Dist, Shenzhen, China 518000 Tel: + 86 755 2335 3855 Fax: + 86 755 2335 3855	DESIGN	CHECK	CHECK	APPROVAL

 Communication Limited	Datasheet		DS10-E013 Final Rev.:2017.01.18	
	Product	SFP+ transceiver OE serials	Ver.	000
	Part No.	OEIS341	Rev.	000
			Page	6 / 7

4) LOS is an open collector output, which should be pulled up with a 4.7k~10kΩ resistor. Pull up voltage between 2.0V and Vcc+0.3V. Logic 1 indicates loss of signal; Logic 0 indicates normal operation. In the low state, the output will be pulled to less than 0.8V.

5) RD-/+ : These are the differential receiver outputs. They are internally AC-coupled 100 differential lines which should be terminated with 100Ω (differential) at the user SERDES.

6) TD-/+ : These are the differential transmitter inputs. They are internally AC-coupled, differential lines with 100Ω differential termination inside the module.

9. Digital Diagnostic Monitor Characteristics

Parameter	Symbol	Min.	Max	
Temperature monitor absolute error	DMI_Temp	-3	3	°C
Laser power monitor absolute error	DMI_TX	-3	3	dBm
RX power monitor absolute error	DMI_RX	-3	3	dBm
Supply voltage monitor absolute error	DMI_VCC	-0.08	0.08	V
Bias current monitor	DMI_Ibias	-10%	10%	mA

10. Mechanical Dimensions:

Comply with SFF-8432, the improved Pluggable form factor specification.

OCRE COMMUNICATION LIMITED Web: www.ocrecom.com E-Mail: sales@ocrecom.com Add. Dist.A, Building 6, Bay on the six block, Xixiang, Baoan Dist, Shenzhen, China 518000 Tel: + 86 755 2335 3855 Fax: + 86 755 2335 3855	DESIGN	CHECK	CHECK	APPROVAL

 CRE Communication Limited	Datasheet		DS10-E013 Final Rev.:2017.01.18	
	Product	SFP+ transceiver OE serials	Ver.	000
	Part No.	OEIS341	Rev.	000
			Page	7 / 7

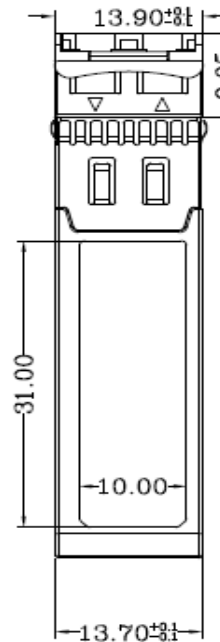
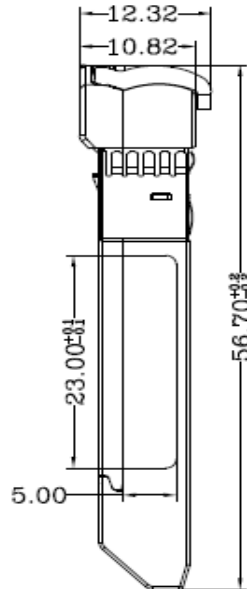
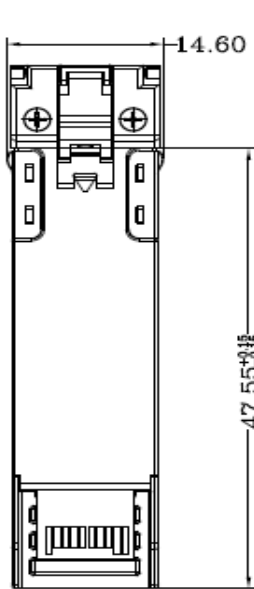
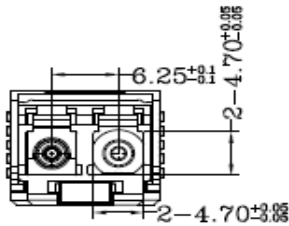

11. Recommended Circuit:

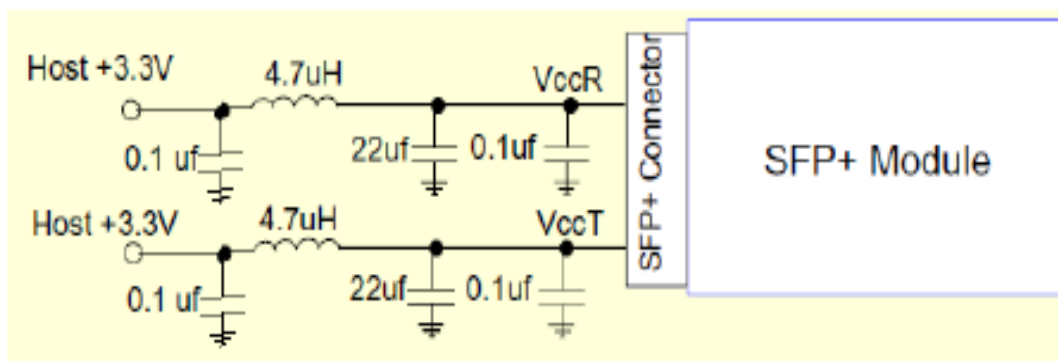

12. Model Name Information

PN	Description
OEIS341	12G SDISFP 1310nm 20KM 0~70°C
OEIS342	12G SDISFP 1310nm 20KM -40~85°C

OCRE COMMUNICATION LIMITED Web: www.ocrecom.com E-Mail: sales@ocrecom.com Add. Dist.A, Building 6, Bay on the six block, Xixiang, Baoan Dist, Shenzhen, China 518000 Tel: + 86 755 2335 3855 Fax: + 86 755 2335 3855	DESIGN	CHECK	CHECK	APPROVAL