



Datasheet

No.

DS10-E003

Initial Date

2010-07-29

OE

OE6S541

Written Team

R&D Dept.

GH Zheng

I Preview

PN	OE6S541
Description	SFP+, ER 40KM

II Contents

1. Features
2. Applications
3. Description
4. Absolute maximum Ratings
5. Operating Environment
6. Optical Characteristics
7. Electrical Characteristics
8. Pin Information
9. SFP+ Module A0、 A2 information and management
10. Digital Diagnostic Monitor Characteristics
11. Regular Compliance
12. Block Diagram of Transceiver
13. Mechanical Dimensions
14. Recommended Circuit
15. Model Name Information

III Revision History

No.	Date	Items	Change Recording	Ver.	Rev.	Customer
1	2010-07-29	All	Initial registration	000	000	Standard
2						
3						
4						
5						
6						

 Communication Limited	Datasheet		DS10-E003 Final Rev.:2010.07.29	
	Product	SFP+ transceiver OE serials	Ver.	000
	Part No.	OE6S541	Rev.	000
			Page	2 / 9

1. Features

- ◆ Hot pluggable
- ◆ 10Gb/s serial optical interface
- ◆ 1550nm EML Laser and PIN receiver
- ◆ Up to 40KM on 9/125um SMF
- ◆ SFP+ MSA package with duplex LC connector
- ◆ 2-wire interface for management and diagnostic monitor
- ◆ SFI High Speed Electrical Interface
- ◆ Very low EMI and excellent ESD protection
- ◆ +3.3V single power supply
- ◆ Power consumption less than 1.0W
- ◆ Operating case temperature: 0~+70°C
- ◆ Compliant with SFF-8431 and SFF-8432
- ◆ Compliant with SFF-8472 Rev 10.2
- ◆ Compliant with IEEE 802.3ae 10GBASE-ER and 10GBASE-EW
- ◆ RoHS Compliant

2. Applications

- ◆ 10G Base- ER/EW
- ◆ 10GE Storage
- ◆ Fiber Channel
- ◆ Other optical links

3. Description

OE6S541 is a very compact 10Gb/s optical transceiver module for serial optical communication applications, supporting data-rate of 10.3125Gbps (10GBASE-ER) or 9.953Gbps (10GBASE-EW), and transmission distance up to 40 km on SMF.

The transceiver consists of two sections: The high performance a 1550nm EML Laser, Transmitter and high sensitivity PIN integrated with a TIA receiver.

The module is hot pluggable into the 20-pin connector. The high-speed electrical interface is based on low voltage logic, with nominal 100 Ohms differential impedance and AC coupled in the module. The optical output can be disabled by

OCRE COMMUNICATION LIMITED Web: www.ocrecom.com E-Mail: sales@ocrecom.com Add. Dist.A, Building 6, Bay on the six block, Xixiang, Baoan Dist, Shenzhen, China 518000 Tel: + 86 755 2335 3855 Fax: + 86 755 2335 3855	DESIGN	CHECK	CHECK	APPROVAL

 CRE Communication Limited	Datasheet		DS10-E003 Final Rev.:2010.07.29	
	Product	SFP+ transceiver OE serials	Ver.	000
	Part No.	OE6S541	Rev.	000
			Page	3 / 9

LVTTTL logic high-level input of TX_Disable. Loss of signal (RX_LOS) output is provided to indicate the loss of an input optical signal of receiver. The receiver RATE_SELECT pin is not used by the transceiver

A 2-wire interface (SCL, SDA) is used for serial ID, digital diagnostics and other control /monitor functions

4. Absolute Maximum Ratings

Parameter	Symbol	Min	Max	Unit
Storage Temperature	T _{ST}	-40	+85	°C
Supply Voltage	V _{CC3}	0.0	+3.6	V
Relative Humidity	RH	5	95	%

5. Operation Environment

Parameter	Symbol	Min	Typ	Max	Unit
Date Rate			10.3125		Gb/s
Supply Voltage	V _{CC}	+3.14	3.3	+3.47	V
Supply Current	I _{CC}			300	mA
Power Dissipation	PD		800	1000	mW
Operating Temperature	T _{OP}	0	25	+70	°C

6. Optical Characteristics (Condition: Ta=TOP)

Parameter	Symbol	Min	Type	Max	Unit	Note	
Transmitter							
Date Rate			10.3125		Gb/s		
Optical Wavelength	λ	1530	1550	1565	nm		
Average output power	P _o	-1		2	dBm	1	
Optical Extinction Ratio	ER	6			dB	1	
Optical Modulation Amplitude	OMA	-5.2			dBm		
Disabled Power	P _{off}	-		-30	dBm		
Side Mode Suppression Ratio	SMSR	30			dB		
Dispersion penalty				3.2	dB		
Tx Jitter	T _{xj}	Per 802.3ae requirements					
Receiver							
Date Rate			10.3125		Gb/s		
Optical Wavelength	λ	1260		1600	nm		
Receiver Sensitivity	R			-15.5	dBm	2	
Receiver Sensitivity in OMA	R			-14.1			
Stressed Receiver Sensitivity in OMA	R			-11.3	dBm	2	

OCRE COMMUNICATION LIMITED Web: www.ocrecom.com E-Mail: sales@ocrecom.com Add. Dist.A, Building 6, Bay on the six block, Xixiang, Baoan Dist, Shenzhen, China 518000 Tel: + 86 755 2335 3855 Fax: + 86 755 2335 3855	DESIGN	CHECK	CHECK	APPROVAL

 CRE Communication Limited	Datasheet		DS10-E003 Final Rev.:2010.07.29	
	Product	SFP+ transceiver OE serials	Ver.	000
	Part No.	OE6S541	Rev.	000
			Page	4 / 9

Maximum Input Power	P _{MAX}	0.5				dBm
LOS De-Assert	LOSD				-16	dBm
LOS Assert	LOSA	-25				dBm
LOS Hysteresis		0.5			4	dB
Receiver Reflectance					-12	dB

Notes:

- 1) Measured at 10.3125b/s with PRBS $2^{31} - 1$ NRZ test pattern.
- 2) Under the ER worst case, measured at 10.3125 Gb/s with PRBS $2^{31} - 1$ NRZ test pattern for BER < 1×10^{-12}

7. Electrical Characteristics (Condition: Ta=TOP)

Parameter	Symbol	Min	Typ	Max	Unit	Note	
Transmitter							
Differential input voltage swing	V _I	150		1600	mV _{pp}	1	
Common mode voltage tolerance		15	-	-	mV		
Transmit Disable Input	H	V _{IH}	2.0		V _{CC} +0.3	V	
	L	V _{IL}	0		0.8	V	
Transmit Enable Output	H	V _{OH}	2.4		V _{CC} +0.3	V	
	L	V _{OL}	0		0.4	V	2
Data Dependent Input Jitter	DDJ			0.1	UI		
Data Input Total Jitter	TJ			0.28	UI		
Input Differential Impedance	Z _{in}	80	100	120	Ω		
Receiver							
Differential output voltage swing		500		700	mV _{pp}	3	
LOS Output	H	V _{OH}	2.4		V _{CC} +0.3	V	2
	L	V _{OL}	0		0.4	V	
Rx Output Rise and Fall Time	T _r /T _f	30			ps	20% to 80%	
Total Jitter	TJ			0.7	UI		
Deterministic Jitter	DJ			0.42	UI		
Output Differential Impedance	Z _{on}	80	100	120	Ω		

Notes:

- 1) TD+/- are internally AC coupled with 100Ω differential termination inside the module.
- 2) Tx Fault and Rx LOS are open collector outputs, which should be pulled up with 4.7k to 10kΩ resistors of the host board. Pull up voltage between 2.0V and V_{CC}+0.3V.
- 3) RD+/- outputs are internally AC coupled, and should be terminated with 100Ω (differential) at the user SERDES.

OCRE COMMUNICATION LIMITED Web: www.ocrecom.com E-Mail: sales@ocrecom.com Add. Dist.A, Building 6, Bay on the six block, Xixiang, Baoan Dist, Shenzhen, China 518000 Tel: + 86 755 2335 3855 Fax: + 86 755 2335 3855	DESIGN	CHECK	CHECK	APPROVAL

 CRE Communication Limited	Datasheet		DS10-E003 Final Rev.:2010.07.29	
	Product	SFP+ transceiver OE serials	Ver.	000
	Part No.	OE6S541	Rev.	000
			Page	5 / 9

8. Pin Information

Diagram of Host Board Connector Block Pin Numbers and Name

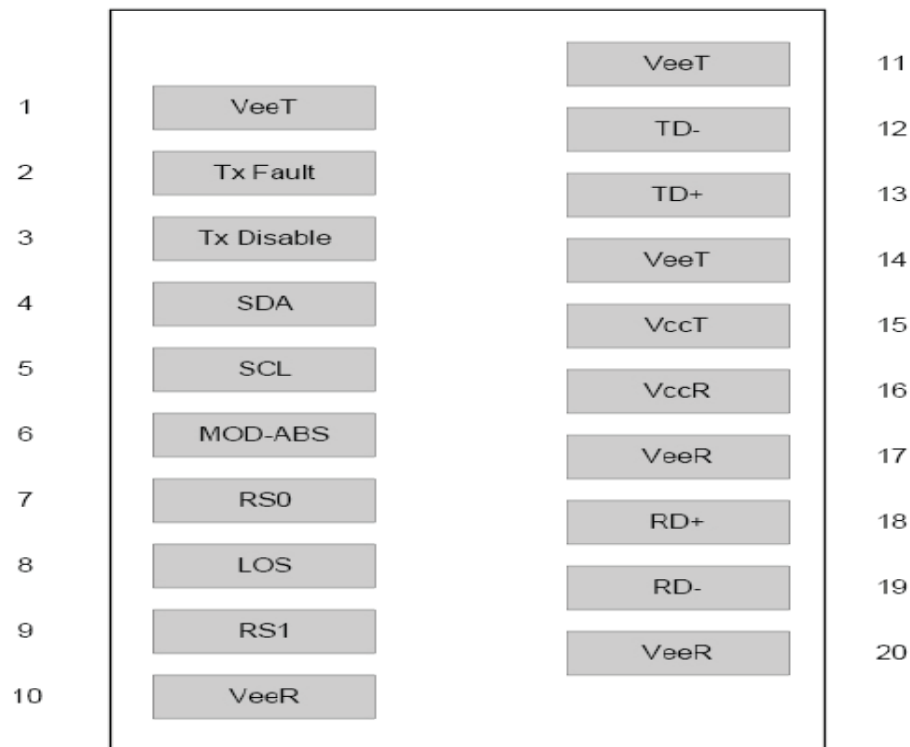

Pin Function Definitions

PIN#	Name	Function	Notes
1	VeeT	Module transmitter ground	Note 1
2	Tx Fault	Module transmitter fault	Note 2
3	Tx Disable	Transmitter Disable; Turns off transmitter laser output	Note 3
4	SDL	2 wire serial interface data input/output (SDA)	
5	SCL	2 wire serial interface clock input (SCL)	
6	MOD-ABS	Module Absent, connect to VeeR or VeeT in the module	Note 2
7	RS0	Receiver Rate Select	
8	LOS	Receiver Loss of Signal Indication	Note 4
9	RS1	Transmitter Rate Select (not used)	
10	VeeR	Module receiver ground	Note 1
11	VeeR	Module receiver ground	Note 1
12	RD-	Receiver inverted data out put	
13	RD+	Receiver non-inverted data out put	
14	VeeR	Module receiver ground	Note 1
15	VccR	Module receiver 3.3V supply	
16	VccT	Module transmitter 3.3V supply	
17	VeeT	Module transmitter ground	Note 1

OCRE COMMUNICATION LIMITED Web: www.ocrecom.com E-Mail: sales@ocrecom.com Add. Dist.A, Building 6, Bay on the six block, Xixiang, Baoan Dist, Shenzhen, China 518000 Tel: + 86 755 2335 3855 Fax: + 86 755 2335 3855	DESIGN	CHECK	CHECK	APPROVAL

 CRE Communication Limited	Datasheet		DS10-E003 Final Rev.:2010.07.29	
	Product	SFP+ transceiver OE serials	Ver.	000
	Part No.	OE6S541	Rev.	000
			Page	6 / 9

18	TD+	Transmitter inverted data out put	
19	TD-	Transmitter non-inverted data out put	
20	VeeT	Module transmitter ground	Note1

Notes:

- 1) The module ground pins shall be isolated from the module case.
- 2) This pin is an open collector/drain output pin and shall be pulled up with 4.7K-10Kohms to Host_Vcc on the host board.
- 3) This pin shall be pulled up with 4.7K-10Kohms to VccT in the module.
- 4) This pin is an open collector/drain output pin and shall be pulled up with 4.7K-10Kohms to Host_Vcc on the host board.

9. SFP Module A0, A2 Information and Management

The SFP+ modules implement the 2-wire serial communication protocol as defined in the SFP -8472.

The serial ID information of the SFP+ modules and Digital Diagnostic Monitor parameters can be accessed through the I2C interface at address A0h and A2h. The memory is mapped in Table 1. Detailed ID information(A0h) is listed in Table 2. And the DDM specification at address A2h. For more details of the memory map and byte definitions, please refer to the SFF-8472, "Digital Diagnostic Monitoring Interface for Optical Transceivers".

Table 1. Digital Diagnostic Memory Map (Specific Data Field Descriptions)

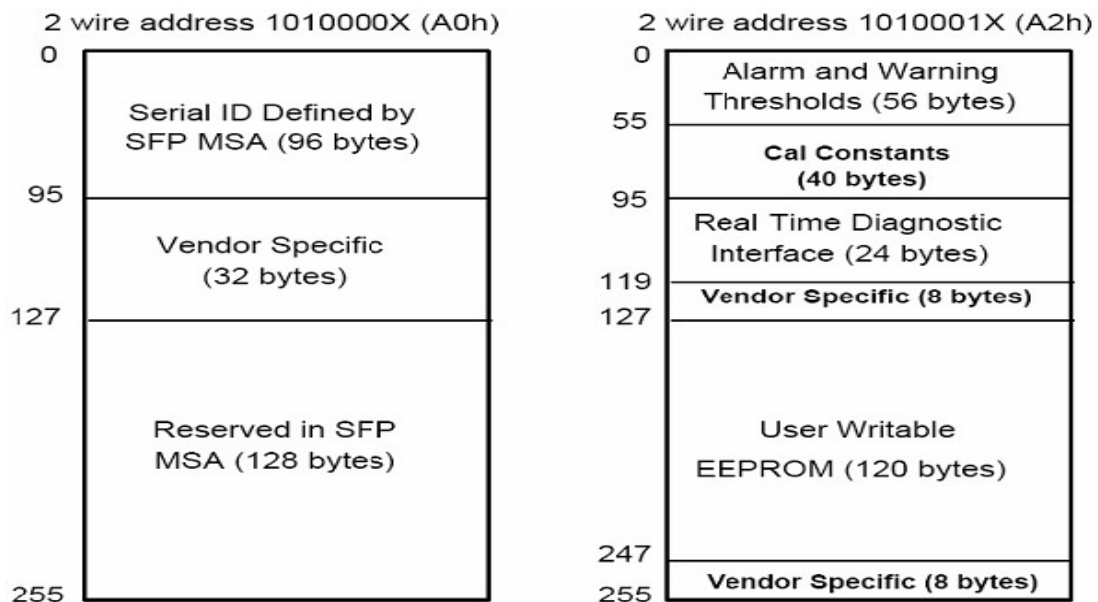



Table 2 - EEPROM Serial ID Memory Contents (A0h)

Data Address	Length (Byte)	Name of Length	Description and Contents
Base ID Fields			

OCRE COMMUNICATION LIMITED Web: www.ocrecom.com E-Mail: sales@ocrecom.com Add. Dist.A, Building 6, Bay on the six block, Xixiang, Baoan Dist, Shenzhen, China 518000 Tel: + 86 755 2335 3855 Fax: + 86 755 2335 3855	DESIGN	CHECK	CHECK	APPROVAL

 Communication Limited	Datasheet		DS10-E003 Final Rev.:2010.07.29	
	Product	SFP+ transceiver OE serials	Ver.	000
	Part No.	OE6S541	Rev.	000
			Page	7 / 9

0	1	Identifier	Type of Serial transceiver (03h=SFP)
1	1	Reserved	Extended identifier of type serial transceiver (04h)
2	1	Connector	Code of optical connector type (07=LC)
3-10	8	Transceiver	
11	1	Encoding	64B/66B (06h)
12	1	BR,Nominal	Nominal baud rate, unit of 100Mbps (67h)
13-14	2	Reserved	(0000h)
15	1	Length(9um)	Link length supported for 9/125um fiber, units of 100m
16	1	Length(50um)	Link length supported for 50/125um fiber, units of 10m
17	1	Length(62.5um)	Link length supported for 62.5/125um fiber, units of 10m
18	1	Length(Copper)	Link length supported for copper, units of meters
19	1	Reserved	
20-35	16	Vendor Name	SFP vendor name: OCRECOM
36	1	Reserved	
37-39	3	Vendor OUI	SFP transceiver vendor OUI ID
40-55	16	Vendor PN	Part Number: "OE6S541" (ASCII)
56-59	4	Vendor rev	Revision level for part number
60-62	3	Reserved	
63	1	CCID	Least significant byte of sum of data in address 0-62
Extended ID Fields			
64-65	2	Option	Indicates which optical SFP signals are implemented (001Ah = LOS, TX_FAULT, TX_DISABLE all supported)
66	1	BR, max	Upper bit rate margin, units of %
67	1	BR, min	Lower bit rate margin, units of %
68-83	16	Vendor SN	Serial number (ASCII)
84-91	8	Date code	OCRECOM's Manufacturing date code
92	1	Diagnostic type	
93	1	Enhanced option	
94	1	SFF-8472	
95	1	CCEX	Check code for the extended ID Fields (addresses 64 to 94)
Vendor Specific ID Fields			
96-127	32	Readable	OCRECOM specific date, read only
128-255	128	Reserved	Reserved for SFF-8079

10. Digital Diagnostic Monitor Characteristics

Parameter	Symbol	Min.	Max	Unit
Temperature monitor absolute error	DML_Temp	-3	3	°C
Laser power monitor absolute error	DML_TX	-3	3	dBm
RX power monitor absolute error	DML_RX	-3	3	dBm
Supply voltage monitor absolute error	DML_VCC	-0.08	0.08	V
Bias current monitor	DML_Ibias	-10%	10%	mA

OCRE COMMUNICATION LIMITED Web: www.ocrecom.com E-Mail: sales@ocrecom.com Add. Dist.A, Building 6, Bay on the six block, Xixiang, Baoan Dist, Shenzhen, China 518000 Tel: + 86 755 2335 3855 Fax: + 86 755 2335 3855	DESIGN	CHECK	CHECK	APPROVAL

 Communication Limited	Datasheet		DS10-E003 Final Rev.:2010.07.29	
	Product	SFP+ transceiver OE serials	Ver.	000
	Part No.	OE6S541	Rev.	000
			Page	8 / 9

11. Regulatory Compliance

The OE6S541 complies with international Electromagnetic Compatibility and international safety requirements and standards (see details in Table following).

Electrostatic Discharge (ESD) to the Electrical Pins	MIL-STD-883E Method 3015.4	Class 1(>2000 V)
Electromagnetic Interference (EMI)	FCC Part 15 Class B EN55022 Class B (CISPR 22B) VCCI Class B	Compatible with standards
Laser Eye Safety	FDA 21CFR 1040.10 and 1040.11 EN60950, EN (IEC) 60825-1,2	Compatible with Class 1 laser product.

12. Block Diagram of Transceiver, A block diagram of the OE6S541 SFP+ optical transceiver is shown below

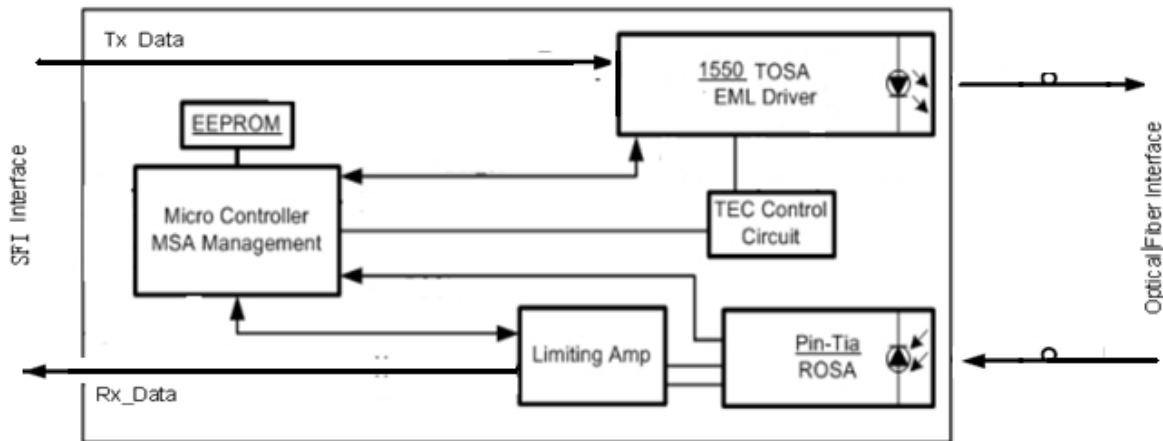

13. Mechanical Dimensions

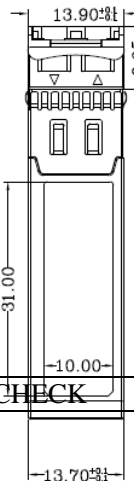
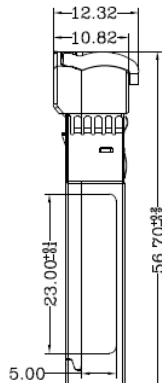
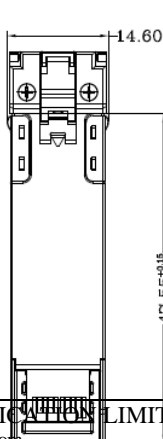
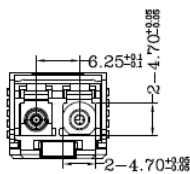

OCRE COMMUNICATIONS LIMITED Web: www.ocrecom.com E-Mail: sales@ocrecom.com Add. Dist.A, Building 6, Bay on the six block, Xixiang, Baoan Dist, Shenzhen, China 518000 Tel: + 86 755 2335 3855 Fax: + 86 755 2335 3855	DESIGN	CHECK	CHECK	APPROVAL

 CRE Communication Limited	Datasheet		DS10-E003 Final Rev.:2010.07.29	
	Product	SFP+ transceiver OE serials	Ver.	000
	Part No.	OE6S541	Rev.	000
			Page	9 / 9

14. Recommended Circuit

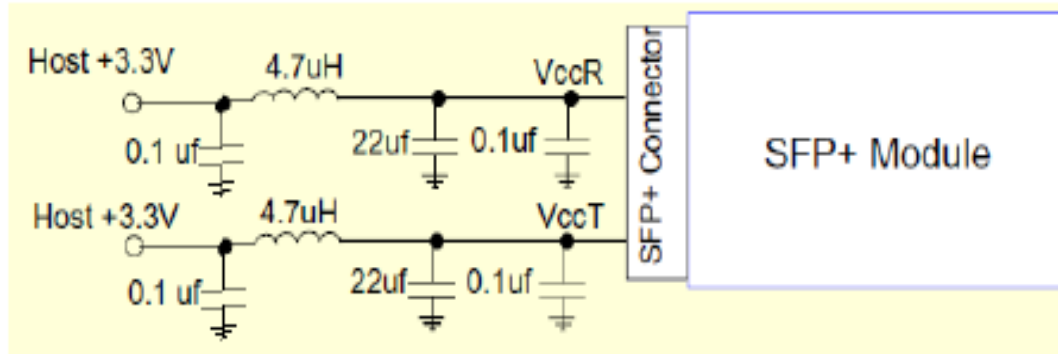

15. Model Name information

PN	Description
OE6S3414	10G SFP+ ER 1310nm 40KM 0~70°C
OE6S3424	10G SFP+ ER 1310nm 40KM -40~85°C
OE6S541	10G SFP+ ER 1550nm 40KM 0~70°C

OCRE COMMUNICATION LIMITED Web: www.ocrecom.com E-Mail: sales@ocrecom.com Add. Dist.A, Building 6, Bay on the six block, Xixiang, Baoan Dist, Shenzhen, China 518000 Tel: + 86 755 2335 3855 Fax: + 86 755 2335 3855	DESIGN	CHECK	CHECK	APPROVAL